

Thank you for taking the time to register and download this month's free downloadable WOOD PLAN. As a special thanks we would like to offer you **25% off** the following plans to complete your Patio suite.



Patio Chair Woodworking Plan (DP-00130)

<http://woodstore.woodmall.com/patiochair.html>

Birdbath Beauty Woodworking Plan (DP-00116)

<http://woodstore.woodmall.com/birdbathbeauty.html>

To redeem your 25% discount just enter **APRILFREE** in the coupon code box when ordering your plans. See below. Offer expires May 10th, 2003.

Coupon or Promotional Code (optional)

If you have a coupon that can be redeemed from WOOD STORE, please enter the offer code in the box below.

-WOOD STORE Team



Out-And-About

Patio Table & Planter



Add pizzazz to
your outdoor spaces
with our matching
table and planter

Patio Planter

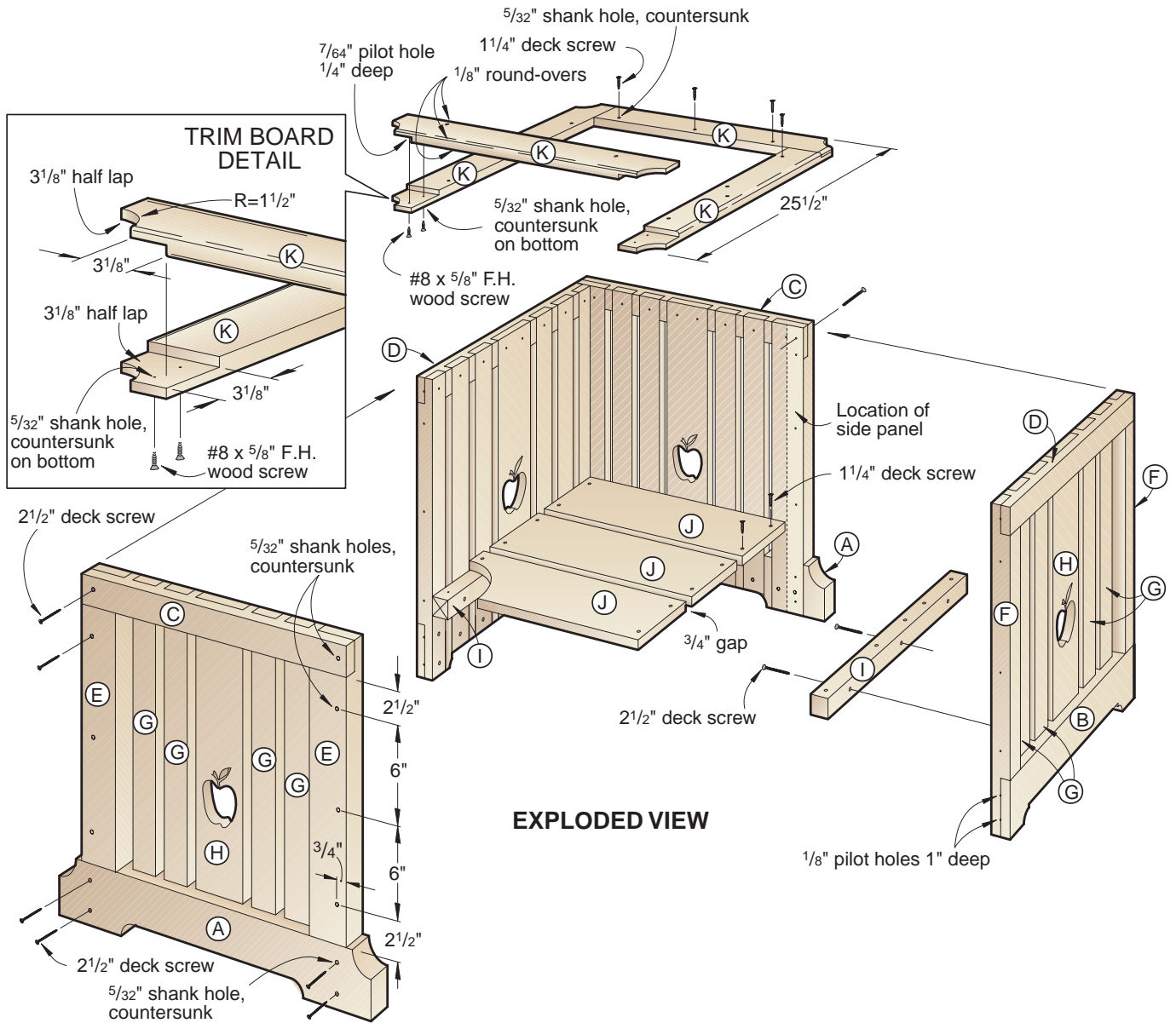

PARTS VIEW

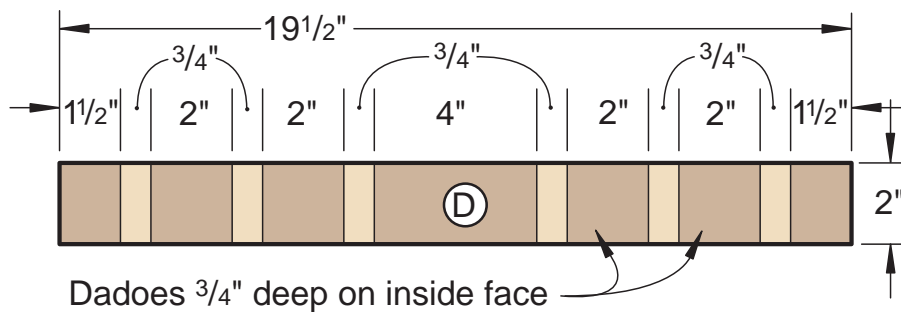
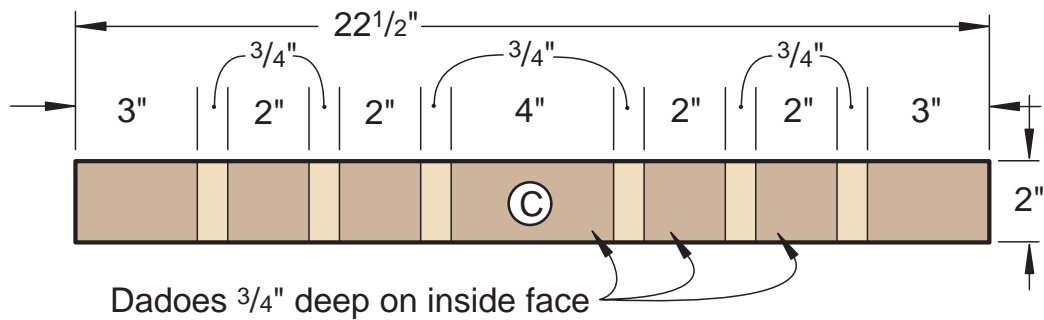
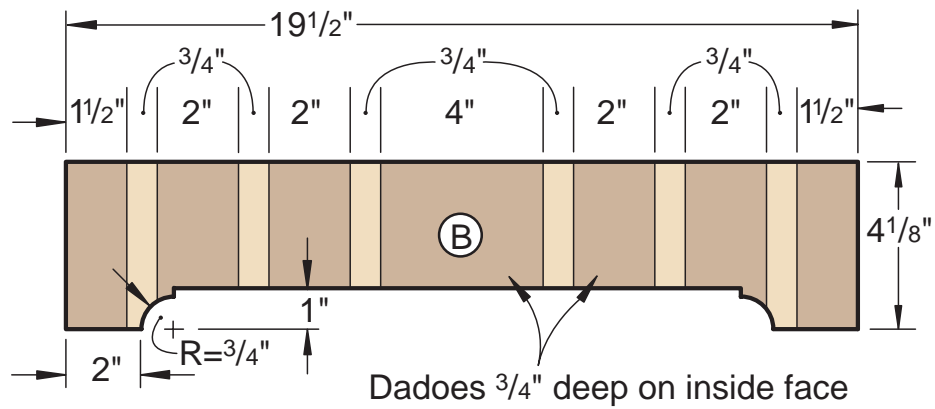
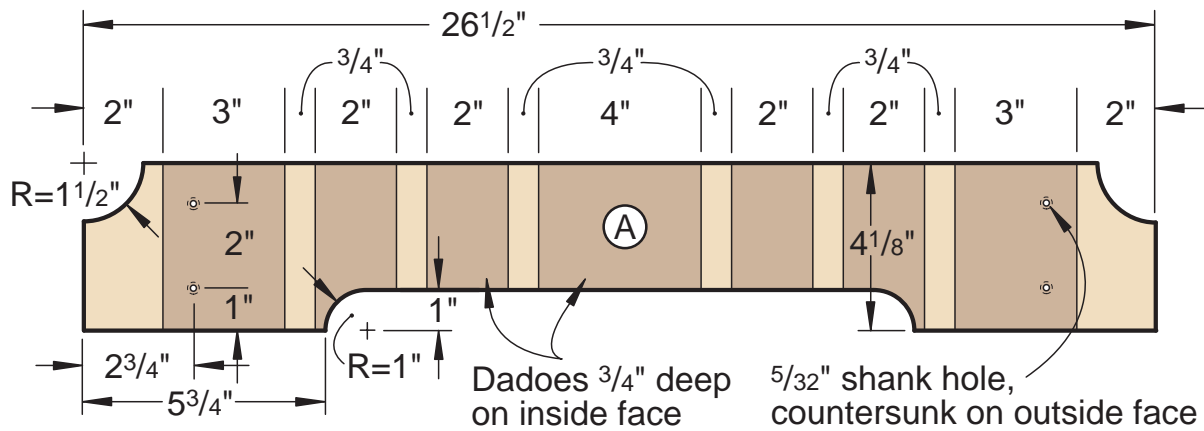

TABLE Bill of Materials

Part	Finished Size			Matl.	Qty.
	T	W	L		
A feet	1½"	4⅛"	26½"	C	2
B feet	1½"	4⅛"	19½"	C	2
C top rails	1½"	2"	22½"	C	2
D top rails	1½"	2"	19½"	C	2
E uprights	1½"	3"	23¼"	C	4
F uprights	1½"	1½"	23¼"	C	4
G slats	¾"	2"	22¼"	C	16
H slats	¾"	4"	22¼"	C	4
I cleats	1½"	1½"	19½"	C	2
J shelf boards	¾"	6"	19½"	C	3
K top trim	¾"	3⅛"	25½"	C	4

Material Key: C-cedar

Supplies: ¼" deck screws, 2½" deck screws, #8x⅝" flathead wood screws, red and green enamel paint, clear exterior finish.

CUTTING DIAGRAM

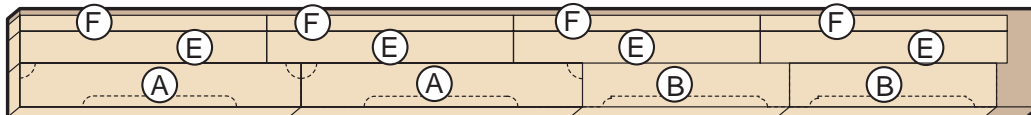

1½ x 9¼ x 96" Cedar (2x10)



1½ x 5½ x 72" Cedar (2x6)

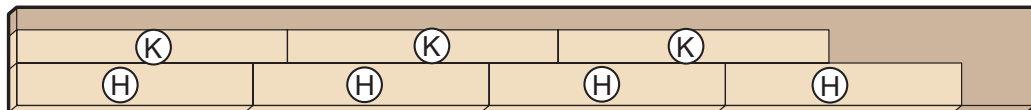

¾ x 9¼ x 96" Cedar (1x10)

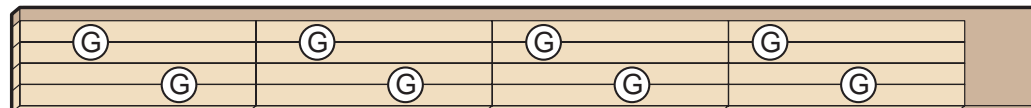

¾ x 9¼ x 96" Cedar (1x10)

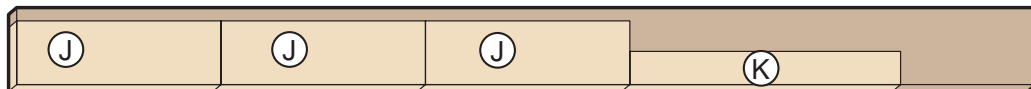

¾ x 7¼ x 96" Cedar (1x8)

Start with planter side and front frames

1 Cut the feet (A, B), top rails (C, D), uprights (E, F), and slats (G, H) to the sizes listed in the Bill of Materials. (We used cedar.)

2 Using the dimensions on the Parts View drawing on *page 3*, mark the dado locations on the feet (A, B) and top rails (C, D). Using the same drawing for reference, mark the radiused outlines on both feet. Using your tablesaw fitted with a dado blade and stop, cut the $\frac{3}{4}$ "-deep dados on all eight pieces. Take your time when marking and cutting for correctly spaced dados.

3 Mark the locations, and cut mating half-lap joints across both ends of the uprights (E, F).

4 Transfer the full-size apple pattern on *page 11* to the center slats (H), $10\frac{1}{4}$ " from the top end of each where shown on the Frames drawing. Drill a blade-start hole, and scrollsaw the patterns to shape. Sand the edges of the cutouts.

5 Cut the bottom edges of the feet (A, B) to shape. Use a drum sander to sand the radii smooth.

6 Paint the apple cutouts in the center slats (H). To do this, brush the surfaces *around and inside* the apple cutouts with lacquer. The lacquer minimizes the wicking of the paint to the surrounding wood. Brush on red and green high-gloss exterior enamel paint. After the paint has dried, sand the lacquer off the surrounding surfaces.

Assemble and connect the four frames

1 Glue and screw each of the four frames together in the configuration shown on the Frames drawing. When assembling each frame, keep the bottom ends of the slats (G, H) flush with the top of the cutout on the bottom side of the feet (A, B). Wipe off the excess glue with a damp cloth.

2 Clamp the side frames between the front and back frames. Drill countersunk mounting holes through the front and back frames

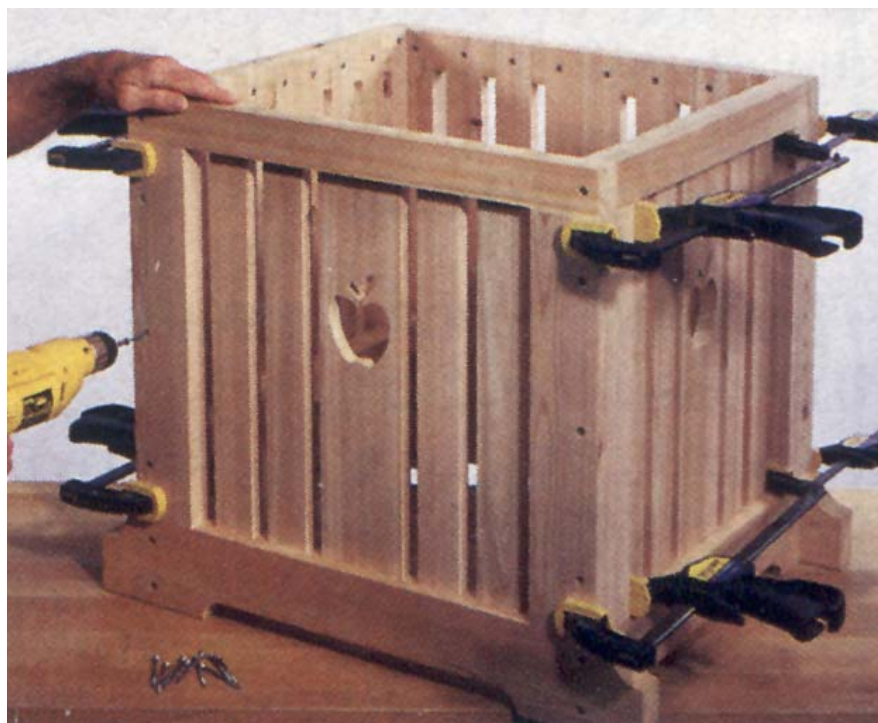

Clamp the side frames between the two end frames, and drive screws to hold the assemblies together.

and into the side frames, where shown on the Exploded View drawing. Use a framing square to check for square and to locate the holes so they're centered in the uprights (F). Drive the screws.

Note: The shelf allows you to raise or lower your potted plant for the best viewing height. In our planter, we positioned the shelf so the top of the pot was about level with the top of the planter.

3 Cut the shelf cleats (I) and shelf boards (J) to size.

4 To locate the shelf for the planter, measure down from the top edge of the planter the height of your flower pot plus $\frac{3}{4}$ ", and make a mark on each side frame upright (F). Next, lay the planter on its side, position the top edge of one cleat (I) even with the marked lines on two of the uprights (F). Drill mounting holes and screw the cleat in place. Repeat for the second cleat on the opposite side of the planter. Then, screw the shelf boards (J) to the cleats, leaving $\frac{3}{4}$ " between each board.

The top trim completes the construction

1 Cut the top trim boards (K) to size. Fit your tablesaw with a dado blade, and cut mating half-lap joints in each. See the Trim Board detail accompanying the Exploded View drawing for reference.

2 Glue and screw the trim boards together, checking for square. Mark a $1\frac{1}{2}$ " radius on each corner, and cut and drum-sand them to shape.

3 Rout a $\frac{1}{8}$ " round-over on all but the bottom inside edge of the trim-board frame, where shown on the Exploded View drawing.

4 Center, then glue and screw the frame to the planter base.

5 Finish-sand the entire planter, and add a quality exterior finish. It's critical to get a good seal on the bottom of the feet (those parts that come in direct contact with the ground or patio). Recoat the planter annually.

FRAMES

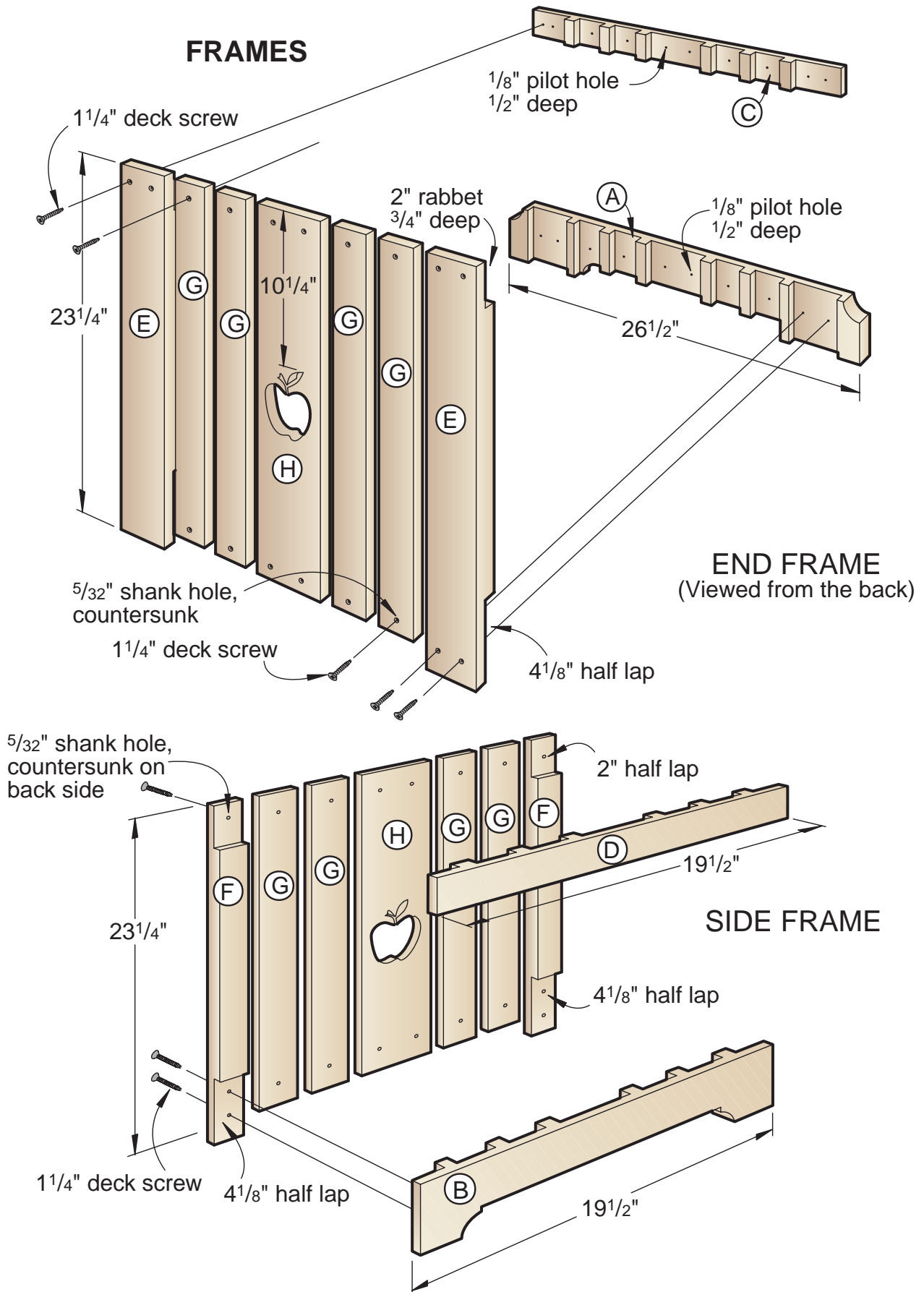

Patio Table

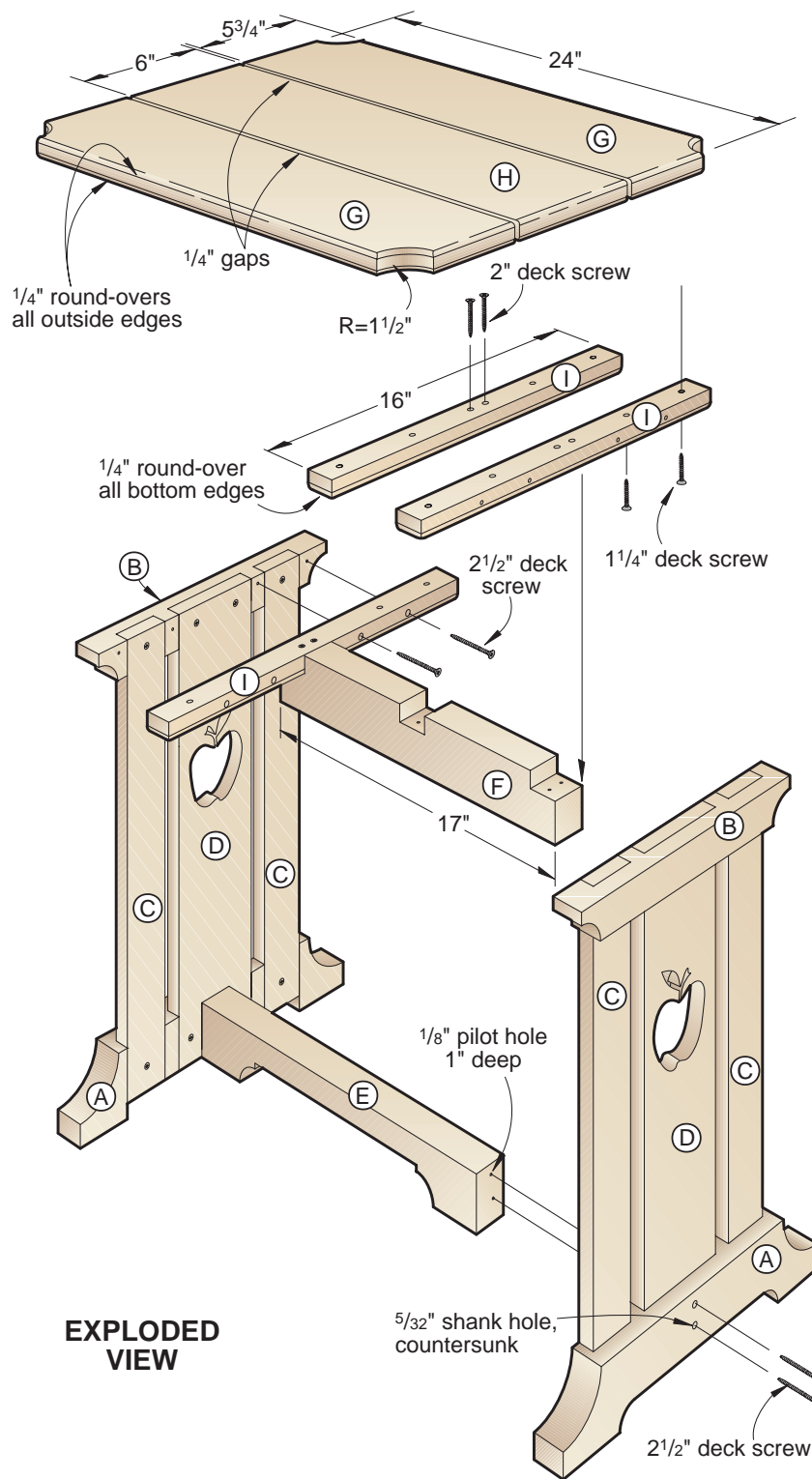

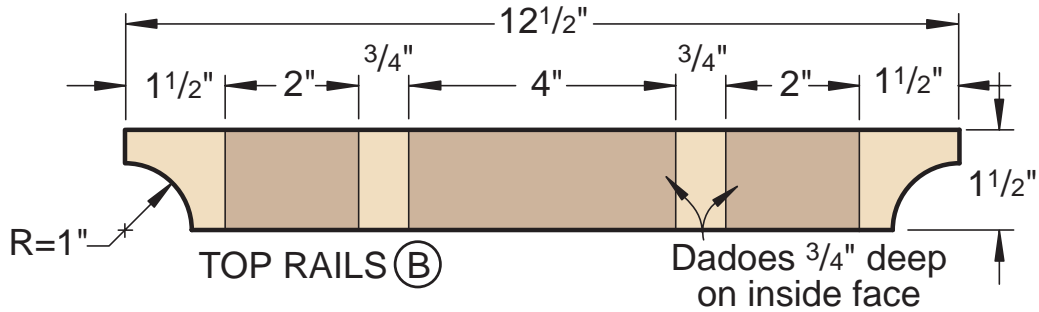

PARTS VIEW

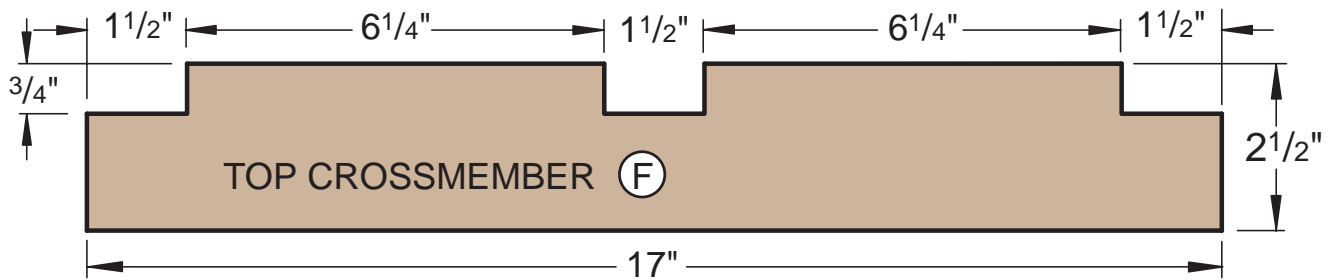

5/32" shank hole, countersunk on outside face

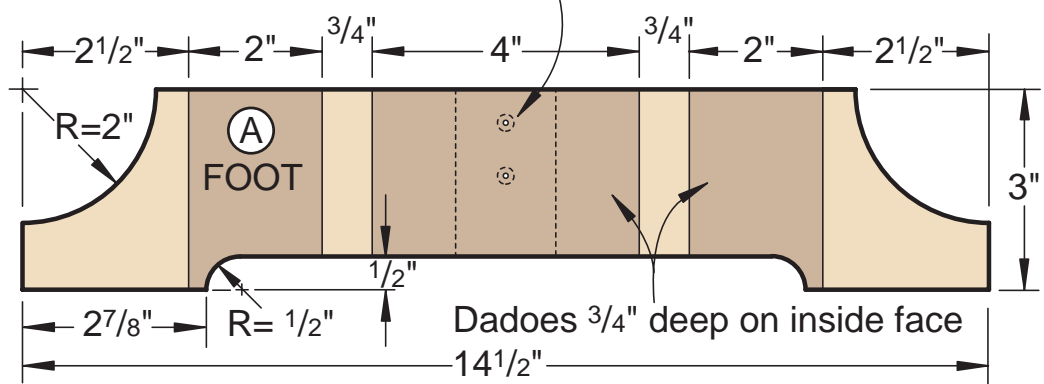
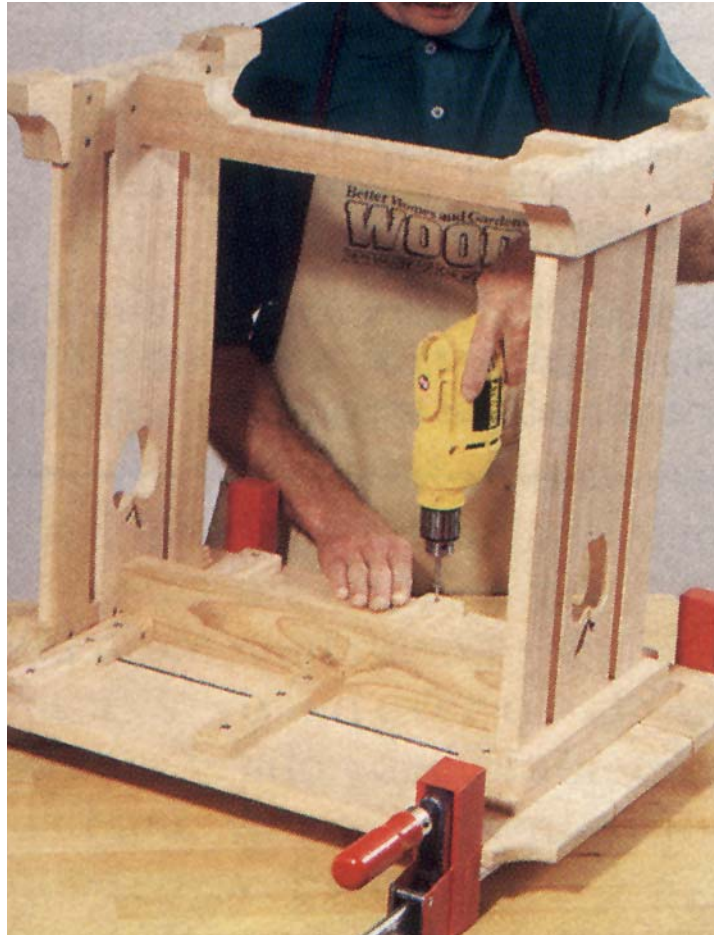

TABLE Bill of Materials

Part	Finished Size			Matl.	Qty.
	T	W	L		
A feet	1½"	3"	14½"	C	2
B top rails	1½"	1½"	12½"	C	2
C slats	¾"	2"	20¼"	C	4
D slats	¾"	4"	20¼"	C	2
E lower crossmember	1½"	2½"	17"	C	1
F upper crossmember	1½"	2½"	17"	C	1
G top boards	¾"	5¾"	24"	C	2
H top center board	¾"	6"	24"	C	1
I cleats	¾"	1½"	16"	C	3

Material Key: C-cedar

Supplies: 1¼" deck screws, 2" deck screws, 2½" deck screws, red and green enamel paint, clear exterior finish.



Clamp the top boards together using spacers for even gaps, then screw the base to the bottom of the top.

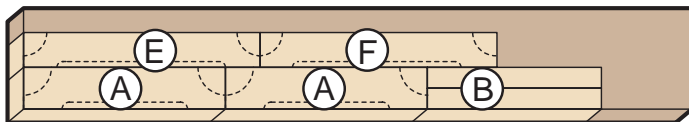

1½ x 7¼ x 48" Cedar (2x8)



¾ x 5½ x 96" Cedar (1x6)



¾ x 7¼ x 96" Cedar (1x8)

CUTTING DIAGRAM

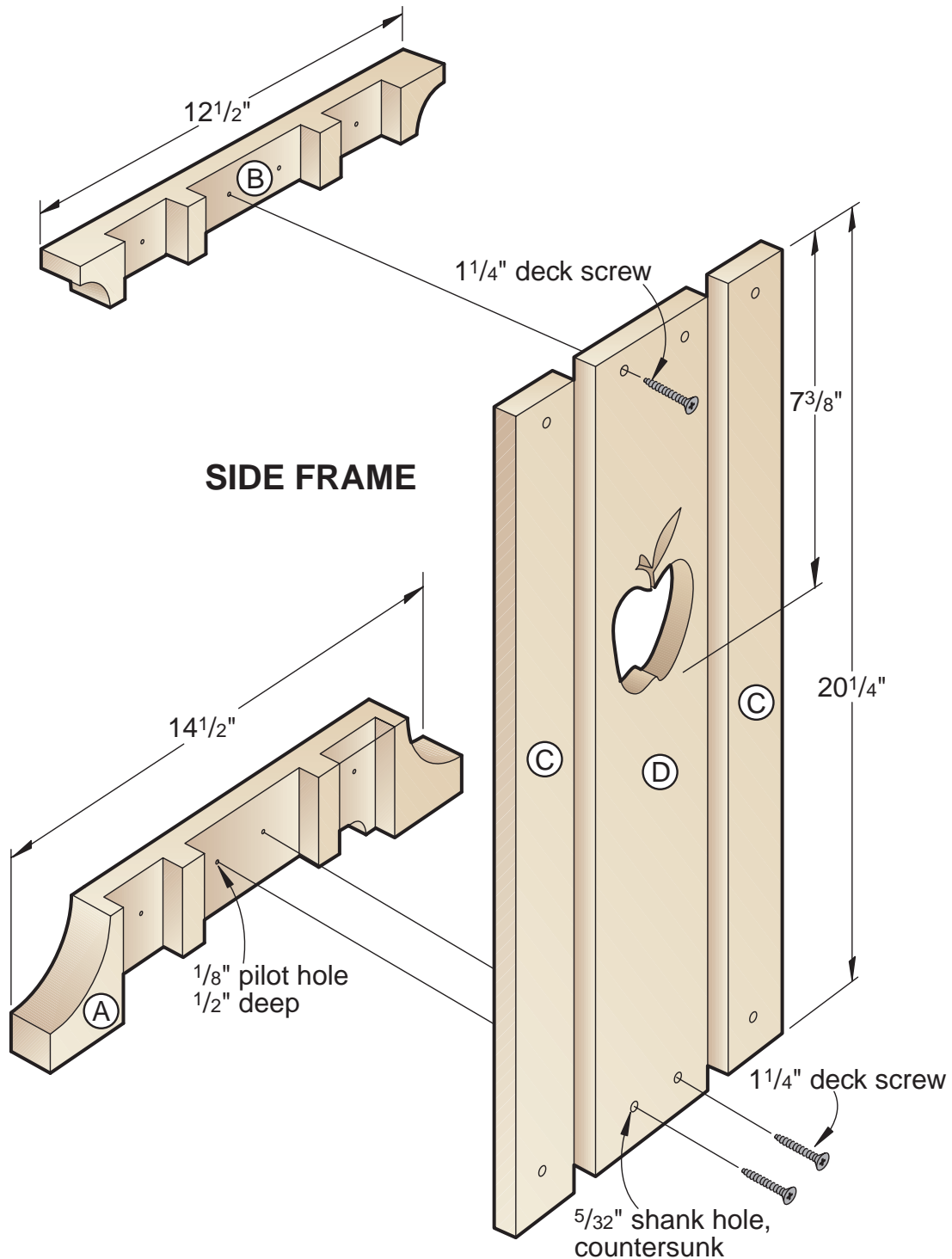

Using a construction procedure similar to that of the planter and chair, build the patio table shown here. See the Parts View on *page 8* for parts A, B, and F. Also see the Bill of Materials on *page 9* for part sizes. Finally, review the Cutting Diagram for laying out the pieces. 🌲

Produced by Marlen Kemmet
 Project Design: James R. Downing
 Illustrations: Jamie Downing; Lorna Johnson
 Graphic Design: Jamie Downing
 Photographs: Hetherington Photography
 ©Copyright Meredith Corporation 2001

The purchase of these plans does not transfer any copyright or other ownership interest in the plans, the design, or the finished project to the buyer. Buyer may neither reproduce the plans for sale nor offer for sale any copies of the finished project.

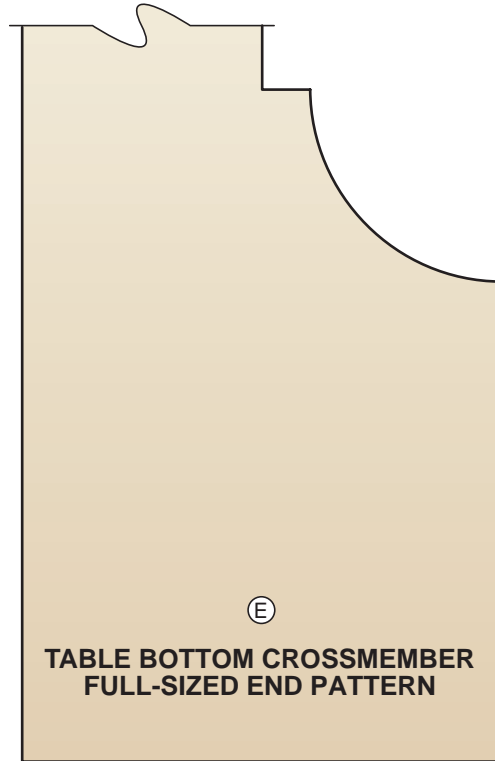
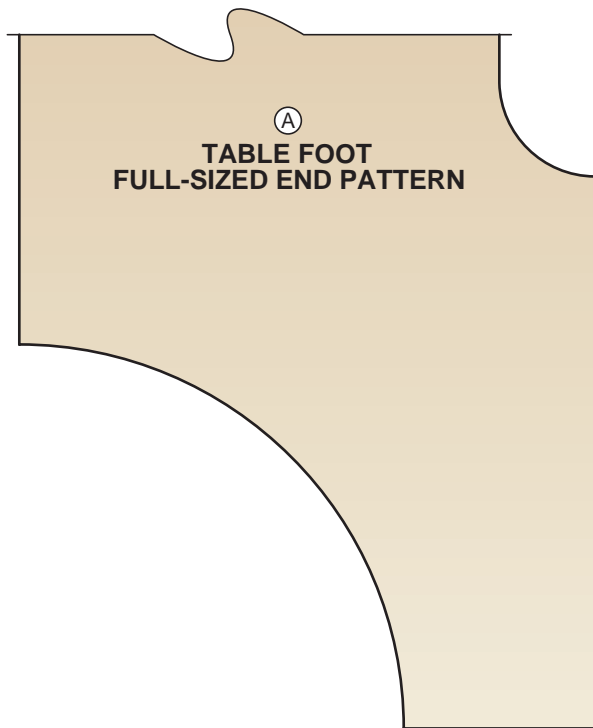

To ensure full-sized patterns are correct size, your printer should be set to print at 100% (not fit to page). Measure full-sized patterns to verify size.

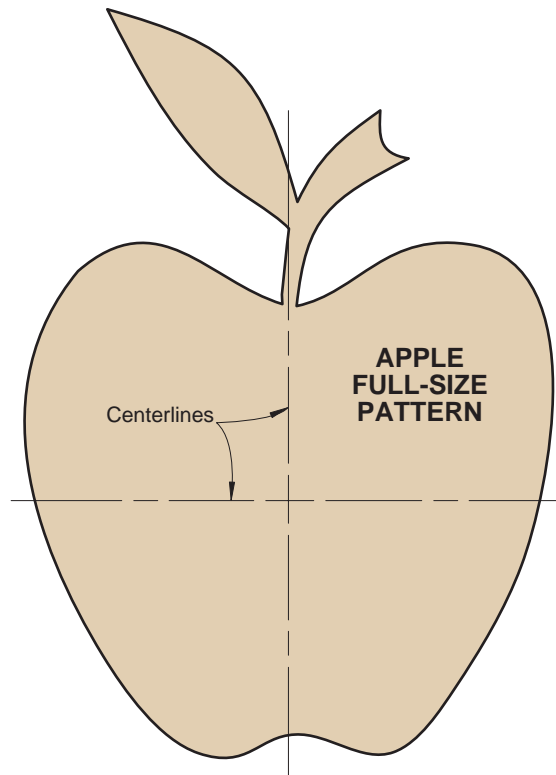
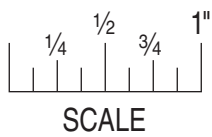

WOODMALL® The Internet's Largest Source for Woodworking Tools and Accessories

<http://www.woodmall.com>

Thanks for your order!

Now that you've got a detailed plan to build that perfect project, visit the WOOD MALL for the internet's largest source for woodworking tools and accessories. The WOOD MALL offers:

- Over two dozen woodworking-related stores
- More than 50,000 tools & accessories
- 24-Hour shopping
- Special sales & closeouts
- Nearly 40 tool comparison charts
- **FREE** monthly woodworking seminar

Visit Today! <http://www.woodmall.com>



Current issue not shown

Like no other magazine, WOOD helps you make the most of your shop time ... takes your skills to the next level. Every issue of WOOD is jam-packed with ...

- Smart tips, tricks, secrets and shortcuts that save you time, effort and money
- Valuable tool reviews with at-a-glance information charts that give you helpful product comparisons
- Giant full-size pattern pull-outs
- Crystal-clear step-by-step instructions, exploded diagrams, finishing secrets and techniques for that professional look – everything you need to bring out your woodworking genius!

- 2 years (14 issues) just \$44 **SAVE \$39.30 off single-copy rate!**
- 1 year (7 issues) just \$26 **SAVE \$15.65 off single-copy rate!**
- Payment Enclosed Bill Me

Fill out information below and mail to: WOOD® Magazine P.O. BOX 37439, Boone, IA. 50037-0439 or Subscribe Online at <http://www.woodmagazine.com/subscribe>

My Name (please print) _____

Address _____ **Apt. #** _____

City _____ **State** _____ **Zip** _____

Canadian Orders: Fill in the form above. Your rate will be 1 year (7 issues) for \$41 – SAVE \$14.65, or 2 years (14 issues) for \$67 – SAVE \$44.30. Prices include postage; 7% GST or 15% HST is added. #12348 2887 RT

U.S. and Canadian subscribers: You also may order by credit card. Call toll free 1-800-374-9663 weekdays from 7 a.m. to 10 p.m. Central Time; Saturdays, 8 a.m. to 3 p.m.; Sundays, 9 a.m. to 3 p.m.

Other International Orders: 2 years for \$89 U.S. or 1 year for \$49 U.S.; prices include postage. To order by credit card call 515/246-6952 during the same hours as listed above (toll charged). Or complete this form; mail with US funds to: WOOD® Magazine, P.O. Box 37439, Boone, IA. 50037-0439 USA.

Your Money-Back Guarantee: You must be satisfied with your subscription or you can get a refund for all unmailed issues.

WOOD® Magazine is published 7 times a year. Savings are based on \$5.95 U.S., \$7.95 Canadian single-copy rate. The first issue mails in 8-12 weeks. Subscription prices subject to change.